

# Kissler TUBULAR WATER SUPPLY

Items in this section are arranged by size order.









	<u>page#</u>		<u>page#</u>		<u>page#</u>
Angle Stops.....	396	Faucet Connectors.....	388, 389	Toilet Connectors.....	390-391
Ball Valves.....	397, 398	Floor & Ceiling Split Plates.....	400	Washing Machine Connectors.....	391
Boiler Drains.....	399	Ice Maker Connectors.....	393	Water Heater Connectors.....	392
Dishwasher Connectors.....	391	Straight Stops.....	396	Water Supply Kits.....	394-395

# Connectors

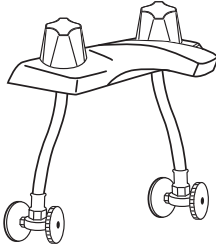
**IAPMO Approved - NSF Approved - High Temperature Reinforced Inner Liner  
Hi-Grade 304 Stainless Steel - 12 Crimp Connection for Added Strength  
Nickel-Plated Brass Hex Nuts - Easy to Install**

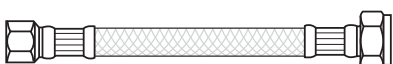

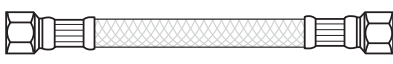
Our Stainless Steel Braided Connectors with reinforced PVC inner liners have a static burst pressure that exceeds 2000 PSI. ALL of our connectors have IAPMO approval and meet the UPC standard for working pressure of 250 PSI, but will work well under 600 PSI @ normal temp.

Description/Fittings		Length	Part #	List Prices			
				1-5	6-49	50-99	100+
<b>for Faucets</b> 	<b>Stainless Steel</b>						
	3/8" Comp. x 1/2" I.P.	9"	<b>88-2019</b>	\$9.00	\$7.50	\$6.00	\$4.35
		12"	<b>88-2001</b>	\$9.60	\$7.95	\$6.30	\$4.20
		16"	<b>88-2016</b>	\$9.90	\$8.25	\$6.60	\$4.80
		20"	<b>88-2002</b>	\$11.10	\$9.15	\$7.35	\$4.80
		24"	<b>88-2024</b>	\$10.20	\$8.40	\$6.75	\$5.85
		30"	<b>88-2003</b>	\$11.40	\$9.45	\$7.50	\$6.00
		36"	<b>88-2036</b>	\$14.25	\$11.85	\$9.45	\$8.40
		48"	<b>88-2004</b>	\$25.05	\$20.85	\$16.65	\$15.00
		60"	<b>88-2260</b>	\$18.00	-	-	-
	<b>Flexible Vinyl</b>						
3/8" Comp. x 1/2" I.P.	9"	<b>88-6619</b>	\$10.50	\$8.40	-	-	
	12"	<b>88-6001</b>	\$10.35	\$8.55	\$6.00	\$3.90	
	16"	<b>88-6125</b>	\$10.80	\$9.00	\$6.30	\$4.80	
	20"	<b>88-6002</b>	\$10.20	\$8.70	\$5.70	\$4.80	
	24"	<b>88-6024</b>	\$10.80	\$9.00	\$5.70	-	
	30"	<b>88-6003</b>	\$11.40	\$9.45	-	-	
	36"	<b>88-6036</b>	\$12.60	\$10.50	-	-	
	48"	<b>88-6004</b>	\$12.75	\$10.65	-	-	
	<b>Stainless Steel</b>						
3/8" Comp. x 3/8" Comp.	12"	<b>88-3910</b>	\$8.70	\$7.20	\$5.70	\$4.80	
	16"	<b>88-3915</b>	\$10.50	\$8.70	\$6.90	\$5.55	
	20"	<b>88-3925</b>	\$11.40	\$9.45	\$7.50	\$5.85	
	30"	<b>88-4430</b>	\$14.55	\$12.15	\$9.75	-	
	<b>Flexible Vinyl</b>						
3/8" Comp. x 3/8" Comp.	12"	<b>88-6031</b>	\$6.30	\$5.25	\$4.20	-	
	20"	<b>88-6038</b>	\$8.40	\$6.90	-	-	
							
	<b>Stainless Steel</b>						
3/8" Comp. x 3/8" Comp. w/ Nut & Ferrule	12"	<b>88-2005</b>	\$11.40	\$9.45	\$6.30	\$4.65	
	20"	<b>88-2006</b>	\$13.20	\$10.95	\$8.70	\$6.90	
							

HONEST MERCHANDISE - ETHICALLY REPRESENTED. KISSLER & CO., Inc. established 1923, makes and distributes precision replacement parts of its own manufacture or procurement. Brand names, model names or stock numbers, which may appear on Seller's invoices, catalogs, packages, quotations or correspondence, are so utilized for purposes of identification only; and are not a warranty or representation, either expressed or implied, that items offered or sold are genuine products of such original manufacturers.

IF YOU DON'T SEE IT... ASK

COPYRIGHT © 2012 BY KISSLER & CO., INC.

CARLSTADT, NEW JERSEY 07072

# Connectors

## for Faucets

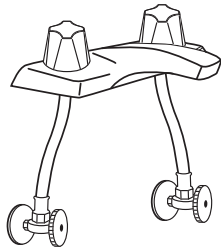

### Stainless Steel

3/8" Flare x 1/2" F.I.P. (for Texas)



Length	Part #	List Prices			
		1-5	6-49	50-99	100+
12"	88-9525	\$7.80	\$6.45	\$5.10	-
16"	88-9530	\$8.10	\$6.75	\$5.40	-
20"	88-9535	\$10.80	\$9.00	\$7.05	-
30"	88-9540	\$8.70	\$7.35	\$6.00	-
36"	88-9545	\$9.45	\$7.95	\$6.45	-

### Stainless Steel

1/2" Comp. x 1/2" F.I.P.

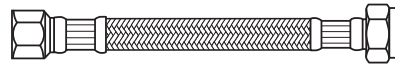

12"	88-1212	\$7.80	\$6.45	\$5.10	\$4.65
16"	88-1216	\$7.80	\$6.45	\$5.10	\$4.65
20"	88-1220	\$9.00	\$7.50	\$6.00	\$5.40
30"	88-3330	\$11.70	\$9.75	\$7.80	-
48"	88-1248	\$18.00	\$15.00	-	-

### Flexible Vinyl

1/2" Comp. x 1/2" F.I.P.

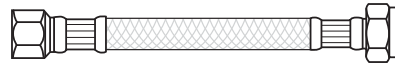

20"	88-6045	\$7.65	\$6.30	-	-
30"	88-6055	\$9.45	\$7.80	-	-

### Stainless Steel

1/2" F.I.P. x 1/2" F.I.P.

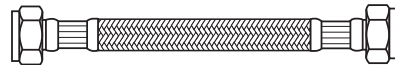

12"	88-3112	\$9.90	\$8.25	\$6.60	\$6.00
20"	88-3120	\$10.80	\$9.00	\$7.05	\$6.30
30"	88-3130	\$16.05	\$13.35	\$9.90	
36"	88-3136	\$16.35	\$13.65	-	
48"	88-3148	\$16.95	-	-	-
60"	88-2065	\$19.95	\$16.65	-	-

### Flexible Vinyl

1/2" F.I.P. x 1/2" F.I.P.

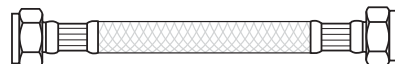

12"	88-6200	\$7.20	\$6.00	-	-
16"	88-6035	\$7.65	\$6.30	-	-
20"	88-6220	\$7.95	\$6.60	-	-

### Stainless Steel

1/2" Flare x 1/2" F.I.P. (for Texas)



12"	88-9500	\$6.75	\$5.55	-	-
16"	88-9505	\$7.05	\$5.85	-	-
20"	88-9510	\$7.80	\$6.45	-	-
36"	88-9516	\$8.40	\$6.90	-	-
48"	88-9520	\$9.00	\$7.50	-	-

HONEST MERCHANDISE - ETHICALLY REPRESENTED. KISSLER & CO., Inc. established 1923, makes and distributes precision replacement parts of its own manufacture or procurement. Brand names, model names or stock numbers, which may appear on Seller's invoices, catalogs, packages, quotations or correspondence, are so utilized for purposes of identification only; and are not a warranty or representation, either expressed or implied, that items offered or sold are genuine products of such original manufacturers.

IF YOU DON'T SEE IT... ASK

# Connectors

## for Toilets

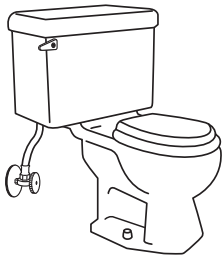

### Stainless Steel

3/8" Comp. x 7/8" Ballcock



Length	Part #	List Prices			
		1-5	6-49	50-99	100+
6"	88-2010	\$6.00	\$4.95	\$3.90	-
9"	88-2007	\$9.60	\$7.95	\$6.30	\$4.50
12"	88-2008	\$9.75	\$8.10	\$6.45	\$4.80
16"	88-2015	\$10.65	\$8.85	\$7.05	\$5.25
20"	88-2009	\$11.70	\$9.75	\$7.80	\$6.00

### Stainless Steel

3/8" Comp x 7/8" Ballcock w/ Brass Nuts



Length	Part #	List Prices			
		1-5	6-49	50-99	100+
9"	88-2907	\$9.45	\$7.80	-	-
12"	88-2908	\$10.65	\$8.85	\$7.05	\$6.45
16"	88-2916	\$11.85	\$9.90	\$7.95	\$7.20
20"	88-2909	\$12.00	\$10.05	\$8.10	-

### Flexible Vinyl

3/8" Comp. x 7/8" Ballcock

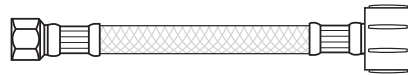

Length	Part #	List Prices			
		1-5	6-49	50-99	100+
9"	88-6009	\$9.00	\$7.05	-	-
12"	88-6014	\$6.90	\$5.70	\$4.50	-
16"	88-6016	\$7.20	\$6.00	-	-
20"	88-6019	\$7.35	\$6.15	-	-

### Stainless Steel

3/8" Flare x 7/8" Ballcock (for Texas)



Length	Part #	List Prices			
		1-5	6-49	50-99	100+
12"	88-9655	\$7.95	\$6.60	-	-
16"	88-9660	\$8.70	\$7.20	-	-
20"	88-9665	\$9.75	\$8.10	-	-

### Stainless Steel

1/2" Comp. x 7/8" Ballcock



Length	Part #	List Prices			
		1-5	6-49	50-99	100+
12"	88-2020	\$9.75	\$8.10	\$6.45	\$5.85
16"	88-2025	\$10.80	\$9.00	\$7.20	-

### Flexible Vinyl

1/2" Comp. x 7/8" Ballcock

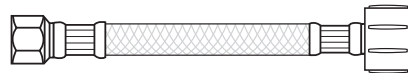

Length	Part #	List Prices			
		1-5	6-49	50-99	100+
12"	88-7012	\$6.90	\$6.00	-	-

### Flexible Vinyl

1/2" Comp. x 7/8" Ballcock w/ Brass Nuts

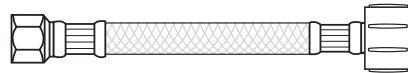

Length	Part #	List Prices			
		1-5	6-49	50-99	100+
12"	88-7112	\$8.25	\$6.90	-	-







HONEST MERCHANDISE - ETHICALLY REPRESENTED. KISSLER & CO., Inc. established 1923, makes and distributes precision replacement parts of its own manufacture or procurement. Brand names, model names or stock numbers, which may appear on Seller's invoices, catalogs, packages, quotations or correspondence, are so utilized for purposes of identification only; and are not a warranty or representation, either expressed or implied, that items offered or sold are genuine products of such original manufacturers.

IF YOU DON'T SEE IT... ASK

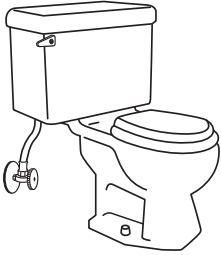
COPYRIGHT © 2012 BY KISSLER & CO., INC.

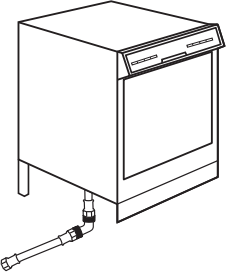
CARLSTADT, NEW JERSEY 07072

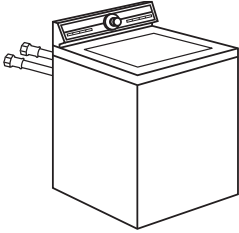
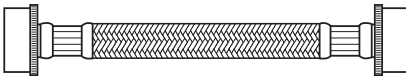
# Connectors

	Description/Fittings	Length	Part #	List Prices			
				1-5	6-49	50-99	100+
<b>for Toilets</b> 	<b>Stainless Steel</b>						
	1/2" Flare x 7/8" Ballcock (for Texas)	9"	<b>88-9600</b>	\$8.70	\$7.20	-	-
		12"	<b>88-9605</b>	\$9.00	\$7.50	-	-
		16"	<b>88-9610</b>	\$9.75	\$8.10	-	-
		20"	<b>88-9615</b>	\$10.50	\$8.70	-	-
<b>for Dishwashers</b> 	<b>Stainless Steel</b>						
	3/8" Comp. x 3/8" Comp. w/ 1/2" Male Elbow	24"	<b>88-2070</b>	\$13.50	\$11.25	\$9.00	-
		48"	<b>88-2048</b>	\$17.25	\$14.40	\$11.55	\$10.50
		60"	<b>88-2060</b>	\$18.75	\$15.60	\$12.35	\$11.25
		72"	<b>88-2072</b>	\$19.80	\$16.50	\$13.20	\$12.00
	<b>Dishwasher Adapter</b>						
	Solid Brass		<b>83-0300</b>	\$10.50	\$8.70	\$6.75	-
							
<b>for Washing Machines</b> 	<b>Stainless Steel</b>						
	3/4" x 3/4"	48"	<b>88-3048</b>	\$21.60	\$18.00	\$14.40	\$12.30
		60"	<b>88-3060</b>	\$26.25	\$21.90	\$17.55	\$15.90
		72"	<b>88-3072</b>	\$28.50	\$23.70	\$18.90	\$16.35
		96"	<b>88-3096</b>	\$33.45	\$27.90	\$22.35	\$20.25
	<b>Rubber Hose</b>						
	3/4" x 3/4"	48"	<b>88-5048</b>	\$13.50	\$11.25	\$9.00	-
		60"	<b>88-5060</b>	\$16.65	\$13.80	\$10.95	\$9.90
		72"	<b>88-5072</b>	\$16.95	\$14.10	\$11.25	-
		96"	<b>88-5096</b>	\$18.75	\$15.60	\$12.30	-
<b>Washing Machine Valve</b>							
	Solid Brass		<b>88-2080</b>	\$46.80	\$39.00	-	-
							



HONEST MERCHANDISE - ETHICALLY REPRESENTED. KISSLER & CO., Inc. established 1923, makes and distributes precision replacement parts of its own manufacture or procurement. Brand names, model names or stock numbers, which may appear on Seller's invoices, catalogs, packages, quotations or correspondence, are so utilized for purposes of identification only; and are not a warranty or representation, either expressed or implied, that items offered or sold are genuine products of such original manufacturers.

IF YOU DON'T SEE IT... ASK

# Connectors

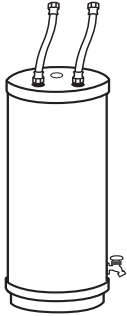
for  
Water  
Heaters

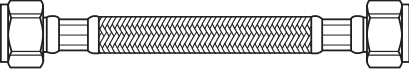
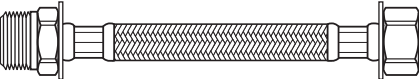

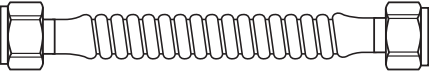
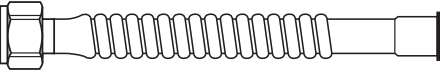
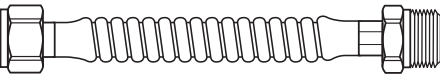
Description/Fittings	Length	Part #	List Prices			
			1-5	6-49	50-99	100+
<b>Stainless Steel</b>						
3/4" F.I.P x 3/4" F.I.P.	12"	<b>88-4012</b>	\$19.50	\$16.20	\$12.90	-
	18"	<b>88-4018</b>	\$21.75	\$18.15	\$14.40	\$13.20
	24"	<b>88-4024</b>	\$24.90	\$20.70	\$16.50	\$15.00
<b>Stainless Steel</b>						
3/4" M.I.P x 3/4" F.I.P.	18"	<b>88-4518</b>	\$32.40	\$27.00	-	-
	24"	<b>88-4524</b>	\$36.00	\$30.00	-	-
	<b>Stainless Steel</b>					
3/4" Comp. x 3/4" F.I.P.	18"	<b>88-3018</b>	\$32.40	\$27.00	-	-
	24"	<b>88-3024</b>	\$36.00	\$30.00	-	-
	<b>Corrugated Copper</b>					
3/4" Female	12"	<b>88-4100</b>	\$26.55	\$22.05	\$17.70	-
	15"	<b>88-4105</b>	\$28.50	\$23.70	\$19.05	-
	18"	<b>88-4110</b>	\$32.10	\$26.70	\$21.45	-
	24"	<b>88-4115</b>	\$38.70	\$32.25	\$25.80	-
	<b>Corrugated Copper</b>					
3/4" F.I.P. x 3/4" Female Sweat	12"	<b>88-4130</b>	\$24.75	\$20.55	\$16.55	-
	15"	<b>88-4135</b>	\$27.15	\$22.65	\$18.15	-
	18"	<b>88-4140</b>	\$30.00	\$25.05	\$20.10	-
	24"	<b>88-4145</b>	\$34.65	\$28.80	\$23.10	-
	<b>Corrugated Copper</b>					
3/4" F.I.P. x 3/4" M.I.P.	12"	<b>88-4160</b>	\$28.05	\$23.40	\$18.75	-
	15"	<b>88-4165</b>	\$30.60	\$25.50	\$20.40	-
	18"	<b>88-4170</b>	\$33.90	\$28.20	\$22.65	-
	24"	<b>88-4175</b>	\$40.05	\$33.30	\$26.70	-



HONEST MERCHANDISE - ETHICALLY REPRESENTED. KISSLER & CO., Inc. established 1923, makes and distributes precision replacement parts of its own manufacture or procurement. Brand names, model names or stock numbers, which may appear on Seller's invoices, catalogs, packages, quotations or correspondence, are so utilized for purposes of identification only; and are not a warranty or representation, either expressed or implied, that items offered or sold are genuine products of such original manufacturers.

IF YOU DON'T SEE IT... ASK

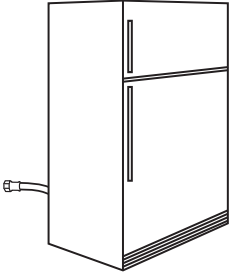

COPYRIGHT © 2012 BY KISSLER & CO., INC.

CARLSTADT, NEW JERSEY 07072

# Connectors

Description/Fittings	Length	Part #	List Prices			
			1-5	6-49	50-99	100+
<b>for Ice Makers</b> <b>Stainless Steel</b> 1/4" Comp. x 1/4" Comp.  	24"	<b>88-6012</b>	\$9.60	\$7.95	\$6.30	-
	60"	<b>88-6060</b>	\$16.20	\$13.50	\$10.35	\$9.45
	84"	<b>88-6084</b>	\$16.65	\$13.80	-	-
	96"	<b>88-6096</b>	\$19.50	\$16.20	-	-
	120"	<b>88-6080</b>	\$24.00	\$19.95	\$15.90	\$14.40
	240"	<b>88-6100</b>	\$64.80	\$54.00	-	-

# Ice Maker Tubing & Accessories

Description	Length	Part #	List Prices				
			1-5	6-49	50-99	100+	
<b>for Ice Makers</b> <b>Plastic Tubing</b> complete with hardware   	25'	<b>88-6025</b>	\$21.60	\$18.00	\$13.50	-	
	<b>Copper Tubing</b> complete with hardware  	15'	<b>88-6015</b>	\$54.00	\$45.00	-	-
		25'	<b>88-6225</b>	\$72.00	\$60.00	-	-
<b>Saddle Valve</b> complete with hardware 		<b>88-6474</b>	\$9.00	\$7.50	-	-	

HONEST MERCHANDISE - ETHICALLY REPRESENTED. KISSLER & CO., Inc. established 1923, makes and distributes precision replacement parts of its own manufacture or procurement. Brand names, model names or stock numbers, which may appear on Seller's invoices, catalogs, packages, quotations or correspondence, are so utilized for purposes of identification only; and are not a warranty or representation, either expressed or implied, that items offered or sold are genuine products of such original manufacturers.

IF YOU DON'T SEE IT... ASK





# Connector Kits

## for Faucets & Toilets

Each Kit comes complete with:

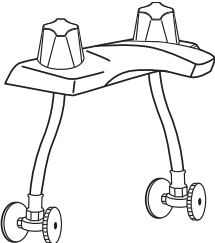
- Floor & Ceiling Plates
- Connectors
- Angle Stops

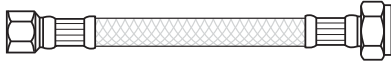

	Description/Fittings	Length	Part #	List Prices	
				1-5	6-49
	<b>Stainless Steel Faucet Connector Kit</b> 3/8" Comp. x 1/2" I.P. <i>Kit Contains:</i> (2) 3/8" F&C Plates, (2) S.S. Faucet Connectors 3/8" x 1/2" x 16" (2) 1/4 Turn Angle Stops 3/8" x 1/2" F.I.P.	16"	88-1005	\$37.80	\$31.50
					
	<b>Stainless Steel Faucet Connector Kit</b> 3/8" Comp. x 1/2" I.P. <i>Kit Contains:</i> (2) 3/8" F&C Plates, (2) S.S. Faucet Connectors 3/8" x 1/2" x 16" (2) 1/4 Turn Angle Stops 3/8" x 5/8" OD Comp.	16"	88-1015	\$37.65	\$31.35
					
	<b>Stainless Steel Faucet Connector Kit</b> 3/8" Comp. x 1/2" I.P. <i>Kit Contains:</i> (2) 3/8" F&C Plates, (2) S.S. Faucet Connectors 3/8" x 1/2" x 20" (2) 1/4 Turn Angle Stops 3/8" x 5/8" OD Comp.	20"	88-1040	\$38.70	\$32.25
					
	<b>Flexible Vinyl Faucet Connector Kit</b> 3/8" Comp. x 1/2" I.P. <i>Kit Contains:</i> (2) 3/8" F&C Plates, (2) Vinyl Faucet Connectors 3/8" x 1/2" x 16" (2) 1/4 Turn Angle Stops 3/8" x 1/2" F.I.P.	16"	88-1000	\$37.20	\$30.90
					



HONEST MERCHANDISE - ETHICALLY REPRESENTED. KISSLER & CO., Inc. established 1923, makes and distributes precision replacement parts of its own manufacture or procurement. Brand names, model names or stock numbers, which may appear on Seller's invoices, catalogs, packages, quotations or correspondence, are so utilized for purposes of identification only; and are not a warranty or representation, either expressed or implied, that items offered or sold are genuine products of such original manufacturers.

IF YOU DON'T SEE IT... ASK

COPYRIGHT © 2012 BY KISSLER & CO., INC.

CARLSTADT, NEW JERSEY 07072

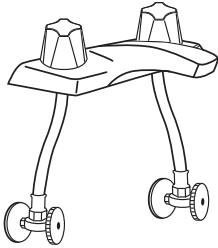
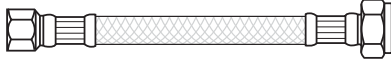
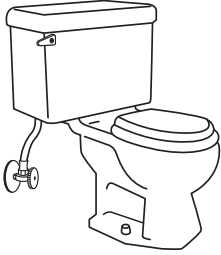
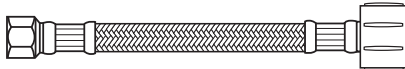
# Connector Kits

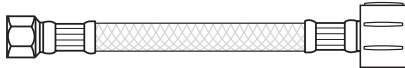
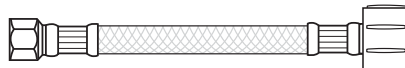
	Description/Fittings	Length	Part #	List Prices	
				1-5	6-49
	<b>Flexible Vinyl Faucet Connector Kit</b> 3/8" Comp. x 1/2" I.P. 16"	<b>88-1010</b> \$34.20	\$28.50		
	<i>Kit Contains:</i> (2) 3/8" F&C Plates, (2) Vinyl Faucet Connectors 3/8" x 1/2" x 16" (2) 1/4 Turn Angle Stops <u>3/8" x 5/8" OD Comp.</u>				
	<b>Stainless Steel Toilet Connector Kit</b> 3/8" Comp. x 7/8" Ballcock 12"	<b>88-1025</b> \$16.20	\$13.50		
	<i>Kit Contains:</i> (1) 3/8" F&C Plate, (1) S.S. Toilet Connector 3/8" x 7/8" x 12" (1) 1/4 Turn Angle Stop <u>3/8" x 1/2" F.I.P.</u>				
	<b>Stainless Steel Toilet Connector Kit</b> 3/8" Comp. x 7/8" Ballcock 12"	<b>88-1035</b> \$17.85	\$14.85		
	<i>Kit Contains:</i> (1) 3/8" F&C Plate, (1) S.S. Toilet Connector 3/8" x 7/8" x 12" (1) 1/4 Turn Angle Stop <u>3/8" x 5/8" OD Comp.</u>				
	<b>Flexible Vinyl Toilet Connector Kit</b> 3/8" Comp. x 7/8" Ballcock 12"	<b>88-1020</b> \$15.15	\$12.60		
	<i>Kit Contains:</i> (1) 3/8" F&C Plate, (1) Vinyl Toilet Connector 3/8" x 7/8" x 12" (1) 1/4 Turn Angle Stop <u>3/8" x 1/2" F.I.P.</u>				
	<b>Flexible Vinyl Toilet Connector Kit</b> 3/8" Comp. x 7/8" Ballcock 12"	<b>88-1030</b> \$16.20	\$13.50		
	<i>Kit Contains:</i> (1) 3/8" F&C Plate, (1) Vinyl Toilet Connector 3/8" x 7/8" x 12" (1) 1/4 Turn Angle Stop <u>3/8" x 5/8" OD Comp.</u>				

HONEST MERCHANDISE - ETHICALLY REPRESENTED. KISSLER & CO., Inc. established 1923, makes and distributes precision replacement parts of its own manufacture or procurement. Brand names, model names or stock numbers, which may appear on Seller's invoices, catalogs, packages, quotations or correspondence, are so utilized for purposes of identification only; and are not a warranty or representation, either expressed or implied, that items offered or sold are genuine products of such original manufacturers.

IF YOU DON'T SEE IT... ASK

# Quarter Turn Stop Valves



**IAPMO Approved - 1/4 Turn Ball Type Stop Valve**  
**Chrome Plated, with Teflon Seat - Easy Turn Handle - Easy to Install**

## Straight Stops



Part #	Inlet x Outlet	List Prices		
		1-5	6-49	50+
88-9260	3/8" Comp. x 3/8" Swivel "Retro Valve"	\$18.90	\$15.75	\$12.60
88-9005	1/2" F.I.P. x 3/8" Comp.	\$11.10	\$9.15	\$7.35
88-9010	1/2" Nom Copper Sweat x 3/8" Comp.	\$11.40	\$9.45	\$7.50
88-9015	5/8" Comp. x 3/8" Comp.	\$12.60	\$10.50	\$8.40
88-9070	3/8" Comp. x 3/8" PEX	\$11.55	\$9.60	\$7.65
88-9020	1/2" PEX x 3/8" Comp.	\$12.45	\$9.15	\$7.35
88-9025	1/2" PEX x 1/2" PEX	\$14.40	\$12.00	\$9.60
88-9030	1/2" PEX w/ Drain Waste x 1/2" PEX	\$24.30	\$20.25	--
88-9035	1/2" CPVC x 3/8" Comp.	\$14.85	\$12.30	\$9.75
88-9040	1/2" F.I.P. x 1/2" Slip Joint	\$12.00	\$9.90	\$7.95
88-9045	5/8" Comp. x 1/2" Slip Joint	\$14.70	\$12.15	\$9.75
88-9055	3/8" Comp. w/ 5" Ext. & Flange x 1/2" Copper	\$28.50	\$23.70	--
88-9000	3/8" F.I.P. x 3/8" Comp.	\$10.50	\$8.70	\$6.90

## Angle Stops



88-9270	3/8" Comp. x 3/8" PEX	\$12.00	\$9.90	\$7.95
88-9200	3/8" F.I.P. x 3/8" Comp.	\$10.80	\$9.00	\$7.20
88-9205	1/2" F.I.P. x 3/8" Comp.	\$11.10	\$9.15	\$7.35
88-9210	1/2" Nom Copper Sweat x 3/8" Comp.	\$12.00	\$9.90	\$7.95
88-9215	5/8" Comp. x 3/8" Comp.	\$12.45	\$10.35	\$8.10
88-9220	1/2" PEX x 3/8" Comp.	\$11.85	\$9.45	\$7.50
88-9230	1/2" CPVC x 3/8" Comp.	\$16.35	\$13.35	\$10.65
88-9235	1/2" F.I.P. x 1/2" Slip Joint	\$13.50	\$11.25	\$9.00
88-9240	5/8" Comp. x 1/2" Slip Joint	\$16.20	\$13.50	\$10.80
88-9250	3/8" Comp. w/ 5" Ext. & Flange x 1/2" Copper	\$27.75	\$23.10	\$18.45
88-9255	1/2" Comp. x 5/8" Comp.	\$16.20	\$13.50	\$10.80

## Dual Outlet Stops



88-9300	1/2" F.I.P. x 3/8" Comp. x 1/4" Comp.	\$19.80	\$16.50	--
88-9305	1/2" F.I.P. x 3/8" Comp. x 3/8" Comp.	\$19.80	\$16.50	\$13.20
88-9310	5/8" Comp. x 3/8" Comp. x 1/4" Comp.	\$19.80	\$16.50	\$13.20
88-9315	5/8" Comp. x 3/8" Comp. x 3/8" Comp.	\$19.80	\$16.50	\$13.20

## Ice Maker Stops



88-9360	1/2" F.I.P. x 1/4" Comp.	\$10.95	\$9.45	\$7.50
88-9375	5/8" Comp. x 1/4" Comp.	\$12.90	\$10.65	\$8.55
88-9385	1/2" CPVC x 1/4" Comp.	\$14.70	\$12.15	\$9.75

HONEST MERCHANDISE - ETHICALLY REPRESENTED. KISSLER & CO., Inc. established 1923, makes and distributes precision replacement parts of its own manufacture or procurement. Brand names, model names or stock numbers, which may appear on Seller's invoices, catalogs, packages, quotations or correspondence, are so utilized for purposes of identification only; and are not a warranty or representation, either expressed or implied, that items offered or sold are genuine products of such original manufacturers.

**IF YOU DON'T SEE IT... ASK**

COPYRIGHT © 2012 BY KISSLER & CO., INC.

CARLSTADT, NEW JERSEY 07072

# Ball Valves

**NSF-61 Certified • Two Piece Hot Forged Brass Body • Explosion-Proof Stem  
Double Teflon O-Ring on Stem • Solid Chrome Plated Brass Ball • Virgin Teflon Seats**

## Full Port - Threaded

Part#	Size	Description	Price	
			1-5	6+
87-1010	1/2"	Full Port Ball Valve - Threaded 600 WOG	\$13.20	\$10.95
87-1015	3/4"	Full Port Ball Valve - Threaded 600 WOG	\$23.85	\$19.80
87-1020	1"	Full Port Ball Valve - Threaded 600 WOG	\$39.60	\$33.00
87-1025	1-1/4"	Full Port Ball Valve - Threaded 600 WOG	\$50.70	\$42.15
87-1030	1-1/2"	Full Port Ball Valve - Threaded 600 WOG	\$79.20	\$66.00
87-1035	2"	Full Port Ball Valve - Threaded 600 WOG	\$111.60	\$93.00



## Full Port - Sweat

Part#	Size	Description	Price	
			1-5	6+
87-1050	1/2"	Full Port Ball Valve - Sweat 600 WOG	\$16.20	\$13.50
87-1055	3/4"	Full Port Ball Valve - Sweat 600 WOG	\$22.50	\$18.75
87-1060	1"	Full Port Ball Valve - Sweat 600 WOG	\$34.20	\$28.50
87-1065	1-1/4"	Full Port Ball Valve - Sweat 600 WOG	\$54.00	\$45.00
87-1070	1-1/2"	Full Port Ball Valve - Sweat 600 WOG	\$79.20	\$66.00
87-1075	2"	Full Port Ball Valve - Sweat 600 WOG	\$115.20	\$96.00



## Full Port w/Waste - Threaded

Part#	Size	Description	Price	
			1-5	6+
87-1090	1/2"	Full Port Ball Valve w/Waste - Threaded 600 WOG	\$21.90	\$18.15
87-1095	3/4"	Full Port Ball Valve w/Waste - Threaded 600 WOG	\$24.30	\$20.25
87-2000	1"	Full Port Ball Valve w/Waste - Threaded 600 WOG	\$39.15	\$32.55



HONEST MERCHANDISE - ETHICALLY REPRESENTED. KISSLER & CO., Inc. established 1923, makes and distributes precision replacement parts of its own manufacture or procurement. Brand names, model names or stock numbers, which may appear on Seller's invoices, catalogs, packages, quotations or correspondence, are so utilized for purposes of identification only; and are not a warranty or representation, either expressed or implied, that items offered or sold are genuine products of such original manufacturers.

**IF YOU DON'T SEE IT... ASK**

# Ball Valves

**NSF-61 Certified • Two Piece Hot Forged Brass Body • Explosion-Proof Stem  
Double Teflon O-Ring on Stem • Solid Chrome Plated Brass Ball • Virgin Teflon Seats**

## Full Port w/Waste - Sweat

Part#	Size	Description	Price	
			1-5	6+
87-2005	1/2"	Full Port Ball Valve - Sweat 600 WOG	\$13.95	\$11.55
87-2010	3/4"	Full Port Ball Valve - Sweat 600 WOG	\$24.60	\$20.40
87-2015	1"	Full Port Ball Valve - Sweat 600 WOG	\$38.70	\$32.25



w/drain



## Full Port - Compression

Part#	Size	Description	Price	
			1-5	6+
87-2020	1/2"	Full Port Ball Valve - Compression ends 400 WOG	\$16.05	\$13.35
87-2025	3/4"	Full Port Ball Valve - Compression ends 400 WOG	\$20.25	\$16.80
87-2030	1"	Full Port Ball Valve - Compression ends 400 WOG	\$28.20	\$23.40



## Pex Brass - Pex x Pex

Part#	Size	Description	Price	
			1-5	6+
87-2035	1/2"	Pex Brass Ball Valve - Pex x Pex 400 WOG	\$14.70	\$12.15
87-2040	3/4"	Pex Brass Ball Valve - Pex x Pex 400 WOG	\$19.20	\$15.90
87-2045	1"	Pex Brass Ball Valve - Pex x Pex 400 WOG	\$36.60	\$30.45
18-0524	3/4"	Backflow Preventer	\$9.00	\$7.50



HONEST MERCHANDISE - ETHICALLY REPRESENTED. KISSLER & CO., Inc. established 1923, makes and distributes precision replacement parts of its own manufacture or procurement. Brand names, model names or stock numbers, which may appear on Seller's invoices, catalogs, packages, quotations or correspondence, are so utilized for purposes of identification only; and are not a warranty or representation, either expressed or implied, that items offered or sold are genuine products of such original manufacturers.

**IF YOU DON'T SEE IT... ASK**

COPYRIGHT © 2012 BY KISSLER & CO., INC.

CARLSTADT, NEW JERSEY 07072

# Boiler Drain Valves

**Solid Brass Construction • Complete with Stuffing Box • NSF-61 Approved**

**Tagged for your Convenience,  
featuring:**

• **Part #** • **Description** • **Barcode**



Part #	Description
<b>87-0500</b>	1/2" Male Boiler Drain Valve 1/2" MIP x Hose
	
Price	
1-5	6-49 50+
\$13.05	\$10.80 \$8.55

Part #	Description
<b>87-0505</b>	3/4" Male Boiler Drain Valve 3/4" MIP x Hose
	
Price	
1-5	6-49 50+
\$14.25	\$11.85 \$9.45

Part #	Description
<b>87-0510</b>	1/2" Female Boiler Drain Valve 1/2" FIP x Hose
	
Price	
1-5	6-49 50+
\$13.50	\$11.25 \$9.00

Part #	Description
<b>87-0515</b>	3/4" Female Boiler Drain Valve 3/4" FIP x Hose
	
Price	
1-5	6-49 50+
\$14.70	\$12.15 \$9.75

Part #	Description
<b>87-0520</b>	1/2" Female Boiler Drain Valve 1/2" FIP w/ PEX Connection
	
Price	
1-5	6-49 50+
\$17.10	\$14.25 call for pricing

HONEST MERCHANDISE - ETHICALLY REPRESENTED. KISSLER & CO., Inc. established 1923, makes and distributes precision replacement parts of its own manufacture or procurement. Brand names, model names or stock numbers, which may appear on Seller's invoices, catalogs, packages, quotations or correspondence, are so utilized for purposes of identification only; and are not a warranty or representation, either expressed or implied, that items offered or sold are genuine products of such original manufacturers.

**IF YOU DON'T SEE IT... ASK**

# Floor & Ceiling Plates

**Durable Plastic Split Plates in 2 Finishes • Sold in Boxes of 12**

## Chrome Plated Plastic



## White Enamel Plastic



### Part # and Description (12 per box)

### Pricing

#### 1-5 boxes

#### 6-49 boxes

#### 50+ boxes

#### 3/8" IPS x 1/2" Copper Tube Size

42-9000 chrome

\$22.50/box

\$18.75/box

\$15.00/box

42-9100 white

\$13.80/box

\$11.40/box

#### 1/2" IPS x 3/4" Copper Tube Size

42-9005 chrome

\$23.85/box

\$19.80/box

\$15.75/box

42-9105 white

\$15.30/box

\$12.60/box

#### 3/4" IPS

42-9010 chrome

\$23.85/box

\$19.80/box

42-9110 white

\$18.00/box

\$15.00/box

#### 1" IPS

42-9015 chrome

\$25.20/box

\$21.00/box

42-9115 white

\$19.50/box

\$16.20/box

#### 1" Copper Tube Size

42-9020 chrome

\$32.40/box

\$27.00/box

42-9120 white

\$19.80/box

\$16.50/box

#### 1-1/4" IPS x 1-1/2" Copper Tube Size

42-9025 chrome

\$36.00/box

\$30.00/box

42-9125 white

\$24.45/box

\$20.40/box

#### 1-1/4" Copper Tube Size

42-9030 chrome

\$39.60/box

\$30.00/box

42-9130 white

\$27.00/box

\$22.50/box

#### 1-1/2" IPS

42-9035 chrome

\$39.60/box

\$33.00/box

42-9135 white

\$25.20/box

\$21.00/box

#### 2" IPS

42-9040 chrome

\$46.80/box

\$39.00/box

42-9140 white

\$27.00/box

\$22.50/box

HONEST MERCHANDISE - ETHICALLY REPRESENTED. KISSLER & CO., Inc. established 1923, makes and distributes precision replacement parts of its own manufacture or procurement. Brand names, model names or stock numbers, which may appear on Seller's invoices, catalogs, packages, quotations or correspondence, are so utilized for purposes of identification only; and are not a warranty or representation, either expressed or implied, that items offered or sold are genuine products of such original manufacturers.

**IF YOU DON'T SEE IT... ASK**

COPYRIGHT © 2012 BY KISSLER & CO., INC.

CARLSTADT, NEW JERSEY 07072

# Compression Fittings

Comp X Comp • Rough Brass

## Brass Compression Unions



**19-0005**  
1/2" Compression Union  
1-5ea    6-49ea  
\$7.20    \$6.00



**19-0010**  
5/8" Compression Union  
1-5ea    6-49ea  
\$9.00    \$7.50



**19-0015**  
3/8" Compression Union  
1-5ea    6-49ea  
\$5.40    \$4.50



**19-0020**  
1/4" Compression Union  
1-5ea    6-49ea  
\$4.35    \$3.60

## Compression Nuts and Sleeves

Sold in Bags of 10



**19-1000**  
1/4" Comp. Nut  
1-5ea    6-49ea  
\$10.80    \$9.00



**19-1005**  
1/4" Comp. Sleeve  
1-5ea    6-49ea  
\$3.30    \$2.70



**19-1010**  
3/8" Comp. Sleeve  
1-5ea    6-49ea  
\$3.60    \$3.00



**19-1015**  
3/8" Comp. Nut  
1-5ea    6-49ea  
\$12.60    \$10.50



**19-1066**  
3/8" Compression Cap  
1-5ea    6-49ea  
\$12.60    \$10.50

## Compression Cap

Sold in Bags of 10

## Pipe Clamps



- Type 301 Stainless Steel Clamps
- Plated malleable iron lugs assure uniform pressure
- Sizes fit IPS Pipe
- Will not collapse schedule 40 PVC Pipe

Description	Part #	1-5	6+
1/2" x 3" Clamp	10-6100	\$10.80	\$9.00
3/4" x 3" Clamp	10-6105	\$11.40	\$9.45
1" x 3" Clamp	10-6110	\$12.00	\$10.05
1-1/2" x 3" Clamp	10-6115	\$13.50	\$11.25
2" x 3" Clamp	10-6120	\$14.10	\$11.70
3/4" x 6" Clamp	10-6125	\$14.55	\$12.15
2" x 6" Clamp	10-6200	\$16.20	\$13.50
2-1/2" x 6" Clamp	10-6225	\$19.80	\$16.50
2-1/2" x 6" Clamp	10-6230	\$21.60	\$18.00

HONEST MERCHANDISE - ETHICALLY REPRESENTED. KISSLER & CO., Inc. established 1923, makes and distributes precision replacement parts of its own manufacture or procurement. Brand names, model names or stock numbers, which may appear on Seller's invoices, catalogs, packages, quotations or correspondence, are so utilized for purposes of identification only; and are not a warranty or representation, either expressed or implied, that items offered or sold are genuine products of such original manufacturers.

IF YOU DON'T SEE IT... ASK

**Kissler** INC

Is proud to announce...

...that we are currently a  
genuine

**GERBER**®  
OEM Master Distributor!



Call or E-Mail for our Special Bulk Parts Program  
**1-800-KISSLER** ■ E-Mail: [sales@kissler.com](mailto:sales@kissler.com)  
or contact your Kissler Sales Representative

**Kissler** INC  
[www.kissler.com](http://www.kissler.com)